

Everything you need to know about  
Airpel Anti-Stiction<sup>®</sup> air cylinders.



***Airpel***<sup>®</sup>  
The Anti-Stiction<sup>®</sup> Air Cylinder.



## Airpel at a Glance

- 1 Stiction: The Air Cylinder Problem
- 2 Features
- 3 Stiction, Not the Only Problem Solved
- 4 Performance Specifications: Imperial & Metric
- 6 Model E9 .366" bore – Imperial
- 8 Model E16 .627" bore – Imperial
- 10 Model E24 .945" bore – Imperial
- 12 Model M9 9.3 mm bore – Metric
- 14 Model M16 15.9 mm bore – Metric
- 16 Model M24 24 mm bore – Metric
- 18 Model M32 32.5 mm bore – Metric
- 19 The Company Behind Airpel
- 20 Other Precision Products

Airpel Division ■ Airpot Corporation ■ 35 Lois Street  
 Norwalk, CT 06851 ■ 1-800-848-7681 ■ Fax: 203-849-0539  
 Email: [service@airpot.com](mailto:service@airpot.com) ■ [www.airpot.com](http://www.airpot.com)

ACC-05J

# Stiction: The air cylinder problem that wouldn't go away—just did.

You encounter problems like stiction every day.

They're the kind of problems that have been around so long, people just assume they'll always be here.

Problems like collar buttons that pop off, tires that go flat, fishing lines that get all tangled up – and on and on.

Nobody devotes much time to solving problems like these. They're just part of life.

Take stiction. It's been around since the discovery of friction. And one of the places it's made itself right at home is in air cylinders.

Just what is stiction? It's that notorious affliction that causes air cylinders to stick at the start of a stroke – resulting in erratic breakaway motion.

Technically, it's the difference between static friction and moving friction when the static friction is higher.

The Airpel Air Cylinder does away with any perceptible stiction. And reduces running friction to exceedingly low levels. This gives

it the unique ability to impart super smooth motion – motion smoother than any other air cylinder. Even at very low pressures. Even at very slow speeds. Even with very short strokes.

*Even after standing idle for years!*

How do you account for this remarkable performance?

The Airpel incorporates a unique construction to become an instrument-quality air cylinder. It uses a precision fit graphite piston which slides freely – *without lubrication* – inside a Pyrex® glass cylinder. This makes it ideal for forces from a very few grams to 70 lbs. or more.

In fact, Airpel is particularly well-suited to applications requiring smooth motion at ultra-low pressures – and to moving lightweight objects or delicate loads at slow or high speeds. It is also ideal for providing precise force control and counterbalancing.

But this air cylinder is no weakling. It can be used to provide brute forces, too – operating under *extreme temperatures*, at very high speeds and cycle rates, with no degradation in performance.

It also *runs cleaner* than typical air cylinders because it contains no oil or grease. What's more, it has no rubber or plastic seals to abrade, wear out, or harden with time.

And because all exposed surfaces (except pivot model bushings) are stainless steel and nickel, Airpel is extremely clean and corrosion resistant.

### AIRPEL VS. TYPICAL AIR CYLINDERS

Pressure vs. Static Friction (5/8" bore air cylinders)

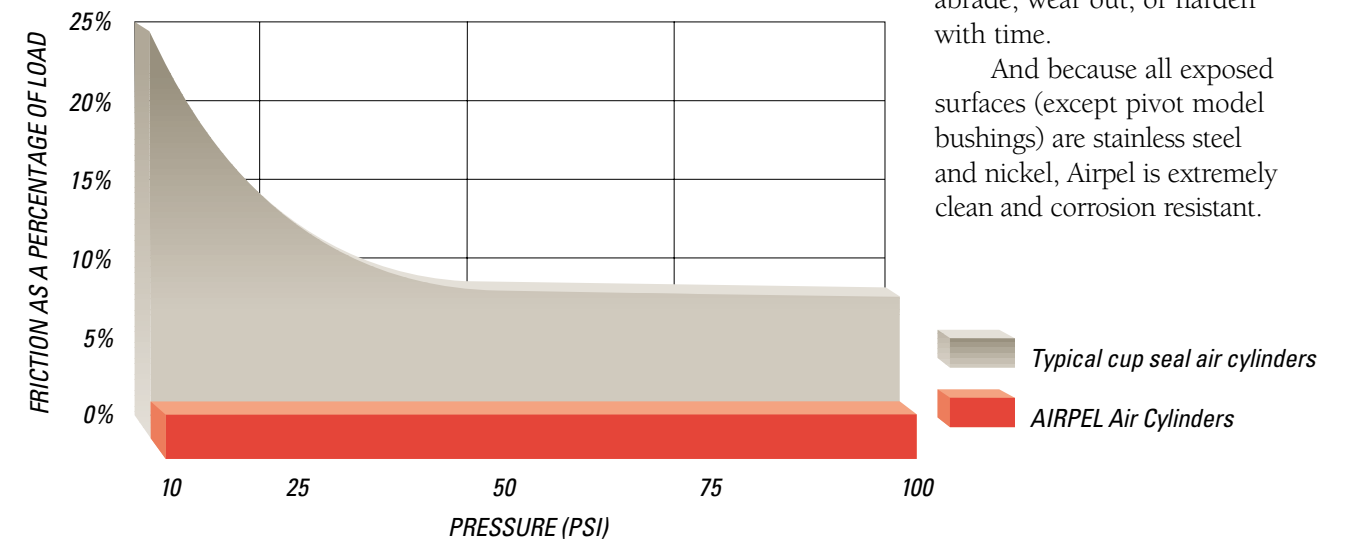



# Features that could be viewed as shortcomings are actually advantages in Airpel.

An air cylinder as revolutionary as Airpel is bound to have features that raise questions. We want you to know these Airpel design points right up front, so you can weigh their importance objectively, and evaluate the benefits they provide in relation to your specific requirements.

*“The Airpel leaks air.”*

### **Advantage: Ultra-low friction.**

In conventional air cylinders, there's a design trade-off: No air leakage (when new) in exchange for higher stiction and running friction.

With Airpel, we chose to go the other way. A little air leakage (not relevant in most applications) in return for ultra-low friction.

To eliminate the leakage would require interference fits between the seal and piston rod, and between the piston and cylinder.

Such interference fits create high friction. A condition far more detrimental than a small air loss.

*“The Airpel has a glass liner.”*

### **Advantage: No corrosion, and no need for lubrication.**

Obviously glass is more fragile than steel. So Airpel's glass liner is encased in a stainless steel sleeve with a small space between. The space provides excellent impact protection, so much so that the outside wall can be dented without affecting the glass liner.

The Airpel can also withstand high stresses without bursting. Our pressure rating of 100 psi is conservative and well within its stress limits.

In fact, if you handle the Airpel the way you would any precision component, you needn't worry about glass breakage at all.

In our reliability testing, we purposely abused the Airpel by striking it with a wedge-shaped 10-lb. weight. The steel cylinder dented, but the piston kept running smoothly

inside the undamaged glass liner. (If you dent a conventional air cylinder, you can expect its operation to be severely impaired because the piston rides against the exposed cylinder.)

We even went to the extreme of striking the cylinder with enough force to smash the glass liner while it was under full pressure. Even at this extreme, the outer cylinder stayed completely intact and, with air lines covering the ports, the glass remained within the cylinder.

What other benefits are there to our Pyrex glass liner?

Its fire-polished surface is inherently smooth and works especially well with our graphite piston to avoid the friction of metals and elastomers.

It doesn't dent, scratch easily, corrode, or ever need lubrication.

And it's dimensionally stable over extreme temperatures without breaking or deforming.

*“Airpel configurations are limited.”*

### **Advantage: Lower costs.**

With Airpel you don't need 20 different bore sizes. Its anti-stick slip and low friction allow it to cover an enormous mix of pressures and forces with fewer models than conventional air cylinders.

The mountings and strokes were also selected to suit the vast majority of applications in this specialized area of response.

Of course, if one of our standard models cannot meet your needs, we will gladly consider custom modifications for OEMs whenever practical, which in our case, is any time you need us.

# Stiction isn't the only problem we've solved.

Since the Airpel air cylinder is so radically different from ordinary air cylinders, we thought we'd keep on going and change something else:

The way they're sold

Airpel cylinders can be purchased through a select network of authorized distributors; we encourage you to contact them whenever possible. Our first interest, however, is insuring that you get what you need, when you need it. So Airpel cylinders can be ordered direct from Airpot Corporation at any time.

Even more importantly, you are not locked into using standard models. Many of our most successful applications have involved customized Airpel constructions developed through collaboration between our engineers and our customers. All Airpot application engineers are also design engineers, so your contact at Airpot will not only be your source of technical informa-

tion, but also the designer and engineering supervisor of any custom configuration we produce for your application.

Whether your special need is as simple as an odd stroke or rod length, or as extreme as a 1/2-inch-high cylinder, we are happy to consider your new ideas and uncommon uses for our products. We encourage you to discuss your novel requirements with us.

In short, we'll do everything humanly and technically possible to assist with your ordering needs. That includes credit card purchasing, JIT and ship-to-the-line deliveries, liberal rescheduling and cancellation policies, and rapid response to all inquiries, requests, and emergency situations.

For complete details on ordering, whether from our distributor, direct from factory, off-the-shelf, or for custom units, please call us.



## Airpel CONSTRUCTION

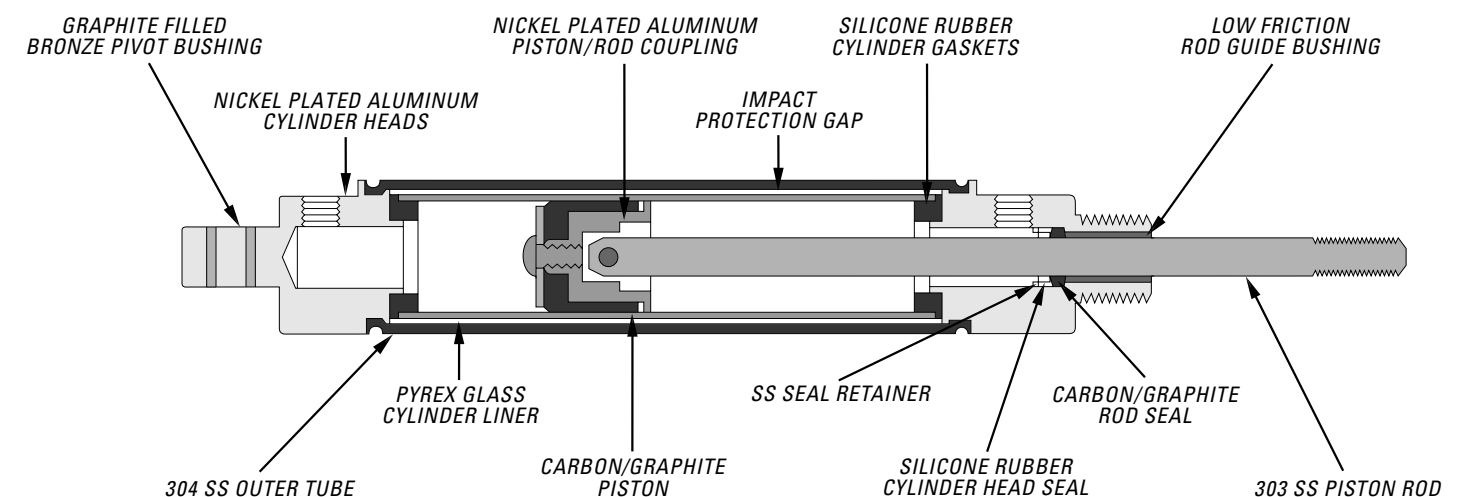

# P E R F O R M A N C E

## Imperial



MODEL	<u>E9</u>	<u>E16</u>	<u>E24</u>
BORE (inches)	0.366	0.627	0.945
PISTON AREA (sq. inch)	0.105	0.307	0.701
PRESSURE RANGE: FULL VACUUM TO-(PSI)	100	100	100
FORCE OUTPUT AT MAX PRESSURE ON REAR SIDE (lbs)	10.5	30.7	70.1
FORCE OUTPUT AT MAX PRESSURE ON ROD SIDE (lbs)	9.3	27.6	65.2
FORCE FACTOR REAR SIDE (factor x pressure = force output)	0.105	0.307	0.701
FORCE FACTOR ROD SIDE (factor x pressure = force output)	0.093	0.276	0.652
MIN PRESSURE DIFFERENTIAL REQUIRED FOR ACTUATION (PSI)	<0.2	<0.2	<0.2
PISTON FRICTION AS % OF LOAD (without side load)	1%–2%	1%–2%	1%–2%
OPERATING TEMPERATURE RANGE	-55° C to +150° C	-55° C to +150° C	-55° C to +150° C
WEIGHT OF PISTON/ROD ASSY (grams) Single rod end models Double rod end models	4.5 + (1.36 x Stroke) 9.93 + (3.24 x Stroke)	16 + (3.6 x Stroke) 29.08 + (8.00 x Stroke)	40.64 + (6.46 x Stroke) 73.28 + (12.92 x Stroke)
WEIGHT OF COMPLETE UNIT (grams) Single rod end models Double rod end models	31.7 + (9.52 x Stroke) 38.46 + (11.74 x Stroke)	64.6 + (15.8 x Stroke) 84.49 + (21.68 x Stroke)	156.42 + (31.12 x Stroke) 203.9 + (37.58 x Stroke)
<b>MAX LEAK AT REFERENCE PRESSURES</b>			
AT PRESSURE PSI=	50	50	50
MAX LEAK RATE by Piston: SL / min*	1.16	1.39	2.2
MAX LEAK RATE by Rod: SL / min*	2.2	2.6	2.6

### Airpel Handling and Mounting Recommendations

■ Tightening torque on mounting nuts should not exceed 60 lb.-in. ■ When threading Airpel directly into a tapped hole, or when tightening the mounting nut, apply tightening/ support wrench to the end being mounted only. ■ The Airpel never needs lubrication. Lubrication applied to any part of the Airpel can impair its Anti-Stiction, low friction properties. ■ For optimum performance, supply air should be filtered using at least a 5 micron, coalescing filter. ■ Whenever possible, avoid bottoming out the piston under pressure. ■ To achieve the lowest possible friction, mount unit so that side loading of the piston rod is minimized. Forceful side loads or side impact on piston rod may damage the unit. NOTE: An unmounted piston rod which does not move freely may indicate cylinder damage. If this condition is present, do not attempt to operate air cylinder. ■ CAUTION: NEVER PRESSURIZE THE AIRPEL WITH ANY PORTS OPEN TO THE ATMOSPHERE. As with any air cylinder, always keep open ports pointed away from eyes. If pneumatic circuit requires an open port, we recommend screening the port with a muffler, filter, or flow control valve.

# S P E C I F I C A T I O N S

## Metric



MODEL	<u>M9</u>	<u>M16</u>	<u>M24</u>	<u>M32</u>
BORE (mm)	9.3	15.9	24.0	32.5
PISTON AREA (sq. mm)	67.7	198	452.5	830
MAX PRESSURE: (MPa)	0.7	0.7	0.7	0.7
SUITABLE FOR VACUUM ACTUATION?	Yes	Yes	Yes	No
FORCE OUTPUT AT MAX PRESSURE ON REAR SIDE (Newtons)	47.4	139	316.6	581
FORCE OUTPUT AT MAX PRESSURE ON ROD SIDE (Newtons)	42	125	294.5	526
Force factor Rear Side (factor x pressure[MPa] = force output [N])	67.7	198	452.5	830
Force factor Rod Side (factor x pressure[MPa] = force output [N])	60	178	420.8	751
MIN PRESSURE DIFFERENTIAL REQUIRED FOR ACTUATION (MPa)	< 0.0015	< 0.0015	< 0.0015	< 0.0035
PISTON FRICTION AS % OF LOAD (without side load)	1%–2%	1%–2%	1%–2%	1%–2%
OPERATING TEMPERATURE RANGE	-55° C to +150° C	-55° C to +150° C	-55° C to +150° C	-55° C to +150° C
WEIGHT OF PISTON/ROD ASSY (grams) Single rod end models Double rod end models	4.5 + (0.053 x Stroke) 8.87 + (0.064 x Stroke)	16 + (0.142 x Stroke) 28.48 + (0.315 x Stroke)	41.4 + (0.254 x Stroke) 74.28 + (0.509 x Stroke)	82.6 + (0.56 x Stroke)
WEIGHT OF COMPLETE UNIT (grams) Single rod end models Double rod end models	31.7 + (0.375 x Stroke) 41.02 + (0.462 x Stroke)	64.6 + (0.622 x Stroke) 80.45 + (0.854 x Stroke)	157.18 + (1.225 x Stroke) 204.9 + (1.480 x Stroke)	616 + (3.66 x Stroke)
<b>MAX LEAK AT REFERENCE PRESSURES</b>				
AT PRESSURE MPa=	0.34	0.34	0.34	0.34
MAX LEAK RATE by Piston: SL / min*	1.16	1.39	2.2	2.2
MAX LEAK RATE by Rod: SL / min*	2.2	2.6	2.6	2.0

\*NOTE: Lower leak rates are available for both Imperial and Metric models upon request. Please consult an Airpot applications engineer by calling (800) 848-7681 or by emailing engineering@airpot.com.

# Model E9

## Bore Size

.366 inch

## Pressure Range

< 0.2 to 100 psi

## Force Factors

Factor times pressure (psi) equals output force (lbs.)

- Rear side .105
- Rod side .093

## Friction Under Pressure

Typically 1%–2% of load in all models

## Temperature Range

-55° Celsius to +150° Celsius  
(-67° F to +302° F)

**Note:** For applications operating below -20° C, it is necessary to add “-ET” to the part number. For example: Model E9D1.0N-ET

## Weight of piston/rod assembly (grams)

Single rod end models  
4.5 + (1.36 x Stroke)

Double rod end models  
9.93 + (3.24 x Stroke)

## Weight (max.) of complete unit (grams)

Single rod end models  
31.7 + (9.52 x Stroke)

Double rod end models  
38.46 + (11.74 x Stroke)

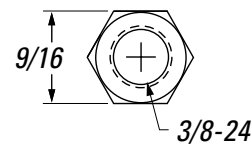

Mounting nut included for all units

DOUBLE ACTING UNITS

SINGLE ACTING UNITS

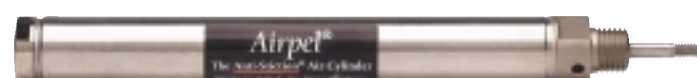
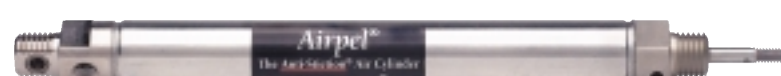
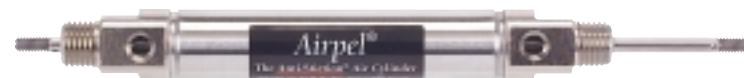
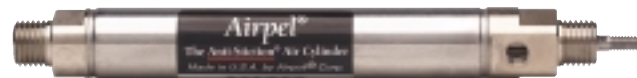
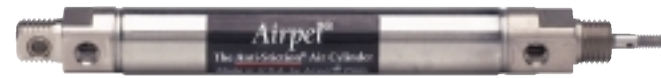

## Part #: E9D...<sub>STROKE</sub>U

Strokes:

0.5–1.0–1.5–2.0–  
3.0–4.0–5.0–6.0–7.0–  
8.0–9.0–10.0–11.0–12.0

Universal mount includes:

- Rear pivot mount
- Front, rear stud mount

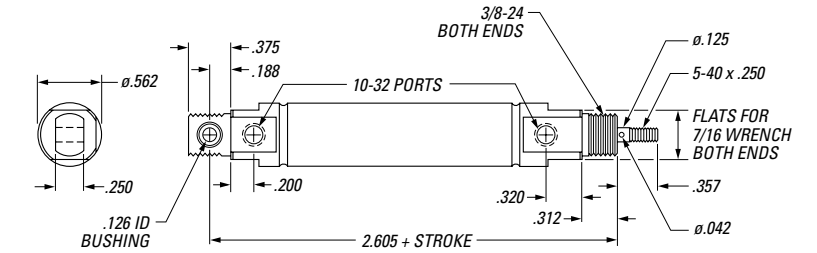

## Part #: E9D...<sub>STROKE</sub>N

Strokes:

0.5–1.0–1.5–2.0–  
3.0–4.0–5.0–6.0–7.0–  
8.0–9.0–10.0–11.0–12.0

Front stud mount

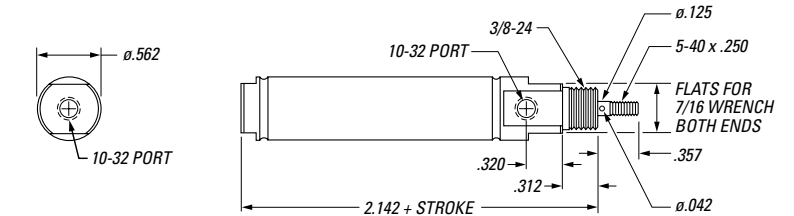

## Part #: E9D...<sub>STROKE</sub>S

Strokes:

0.5–1.0–1.5–2.0–  
3.0–4.0–5.0–6.0–7.0–  
8.0–9.0–10.0–11.0–12.0

Front, rear stud mount

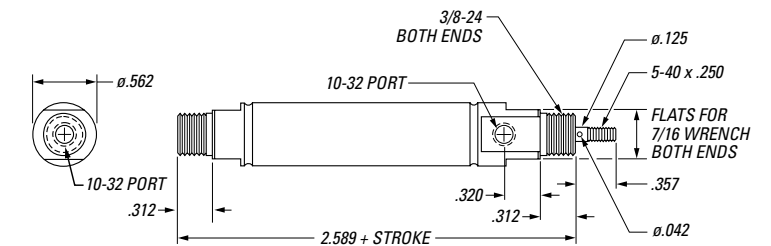

## Part #: E9D...<sub>STROKE</sub>D

Strokes:

0.5–1.0–1.5–2.0–  
3.0–4.0–5.0–6.0–7.0–  
8.0–9.0–10.0–11.0–12.0

Double rod end

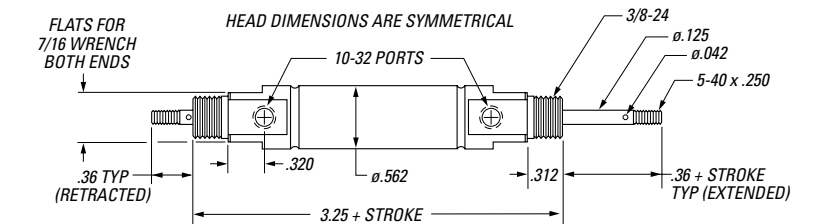

## Part #: E9X...<sub>STROKE</sub>U

Air extend, spring return

Strokes: 0.5–1.0–1.5

Universal mount includes:

- Rear pivot mount
- Front, rear stud mount

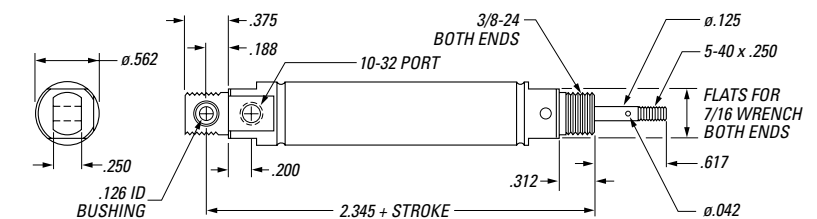

## Part #: E9X...<sub>STROKE</sub>N

Air extend, spring return

Strokes: 0.5–1.0–1.5

Front stud mount

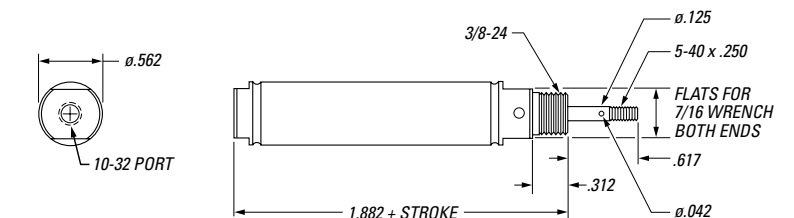

RESET SPRING FORCE FOR SINGLE ACTING UNITS (lbs.)			
Stroke	0.5	1.0	1.5
Rod Extended	.17	.17	.17
Rod Retracted	.12	.08	.05



# Model E16

## Bore Size

.627 inch

## Pressure Range

< 0.2 to 100 psi

## Force Factors

Factor times pressure (psi) equals output force (lbs.)

- Rear side .307
- Rod side .276

## Friction Under Pressure

Typically 1%–2% of load in all models

## Temperature Range

-55° Celsius to +150° Celsius  
(-67° F to +302° F)

**Note:** For applications operating below -20° C, it is necessary to add “-ET” to the part number. For example: Model E16D1.0N-ET

## Weight of piston/rod assembly (grams)

Single rod end models  
16 + (3.6 x Stroke)

Double rod end models  
29.08 + (8.00 x Stroke)

## Weight (max.) of complete unit (grams)

Single rod end models  
64.6 + (15.8 x Stroke)

Double rod end models  
84.49 + (21.68 x Stroke)

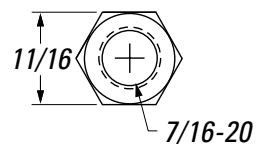

Mounting nut included for all units

DOUBLE ACTING UNITS

SINGLE ACTING UNITS

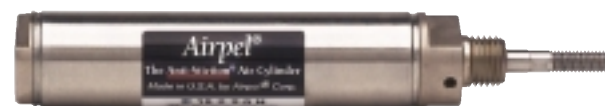
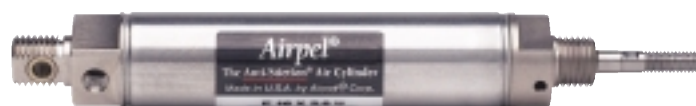

## Part #: E16D<sub>STROKE</sub>U

Strokes:

0.5–1.0–1.5–2.0–  
3.0–4.0–5.0–6.0–7.0–  
8.0–9.0–10.0–11.0–12.0

Universal mount includes:

- Rear pivot mount
- Front, rear stud mount

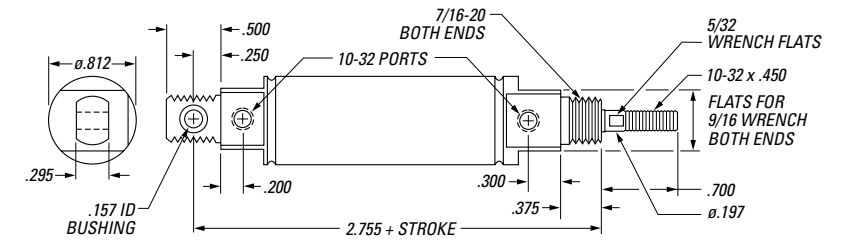

## Part #: E16D<sub>STROKE</sub>N

Strokes:

0.5–1.0–1.5–2.0–  
3.0–4.0–5.0–6.0–7.0–  
8.0–9.0–10.0–11.0–12.0

Front stud mount

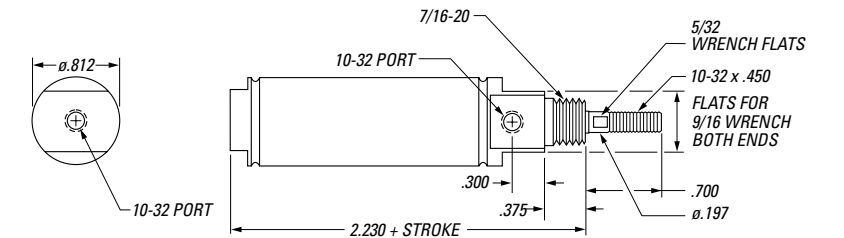

## Part #: E16D<sub>STROKE</sub>S

Strokes:

0.5–1.0–1.5–2.0–  
3.0–4.0–5.0–6.0–7.0–  
8.0–9.0–10.0–11.0–12.0

Front, rear stud mount

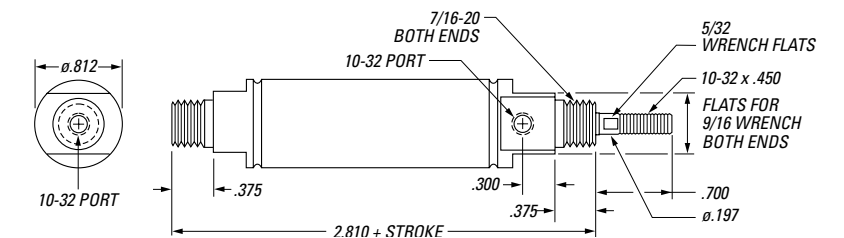

## Part #: E16D<sub>STROKE</sub>D

Strokes:

0.5–1.0–1.5–2.0–  
3.0–4.0–5.0–6.0–7.0–  
8.0–9.0–10.0–11.0–12.0

Double rod end

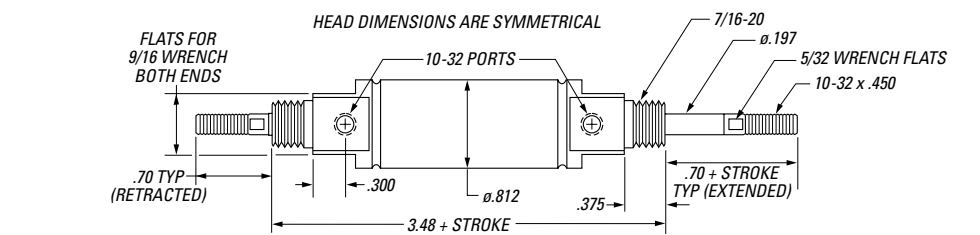

## Part #: E16X<sub>STROKE</sub>U

Air extend, spring return

Strokes: 0.5–1.0–1.5–2.0

Universal mount includes:

- Rear pivot mount
- Front, rear stud mount

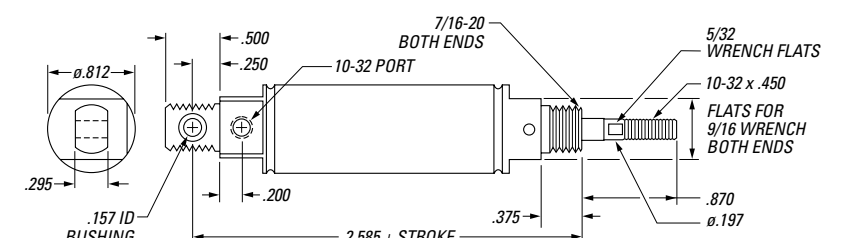

## Part #: E16X<sub>STROKE</sub>N

Air extend, spring return

Strokes: 0.5–1.0–1.5–2.0

Front stud mount

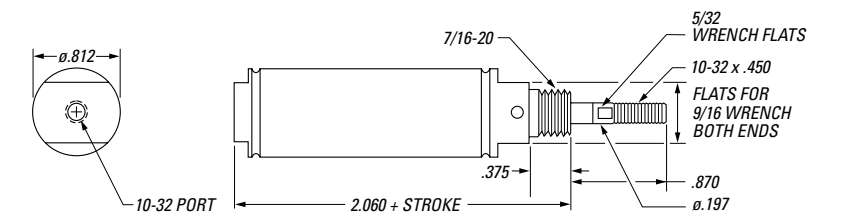

RESET SPRING FORCE FOR SINGLE ACTING UNITS (lbs.)				
Stroke	0.5	1.0	1.5	2.0
Rod Extended	.25	.25	.25	.25
Rod Retracted	.22	.20	.17	.15

# Model E24

## Bore Size

.945 inch

## Pressure Range

< 0.2 to 100 psi

## Force Factors

Factor times pressure (psi) equals output force (lbs.)

- Rear side .701
- Rod side .652

## Friction Under Pressure

Typically 1%–2% of load in all models

## Temperature Range

-55° Celsius to +150° Celsius  
(-67° F to +302° F)

**Note:** For applications operating below -20° C, it is necessary to add “-ET” to the part number. For example: Model E24D1.0N-ET

## Weight of piston/rod assembly (grams)

Single rod end models  
40.6 + (6.46 x Stroke)

Double rod end models  
73.28 + (12.92 x Stroke)

## Weight (max.) of complete unit (grams)

Single rod end models  
156.4 + (31.12 x Stroke)

Double rod end models  
203.9 + (37.58 x Stroke)

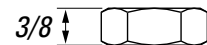
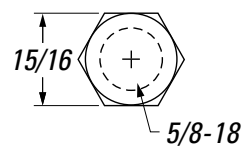

Mounting nut included for all units

DOUBLE ACTING UNITS



## Part #: E24D...U

Strokes:  
0.5–1.0–1.5–2.0–  
3.0–4.0–5.0–6.0–7.0–  
8.0–9.0–10.0–11.0–12.0

Universal mount includes:  
• Rear pivot mount  
• Front, rear stud mount

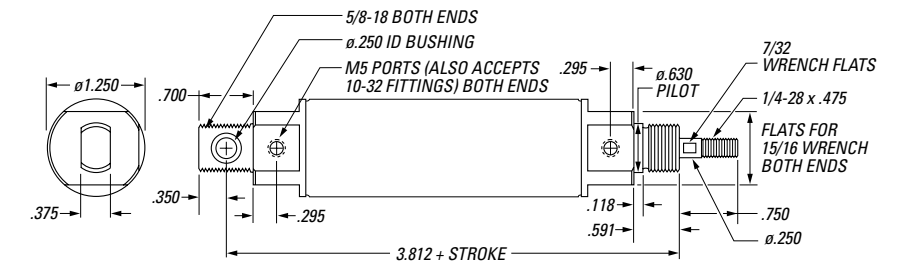

## Part #: E24D...N

Strokes:  
0.5–1.0–1.5–2.0–  
3.0–4.0–5.0–6.0–7.0–  
8.0–9.0–10.0–11.0–12.0

Front stud mount

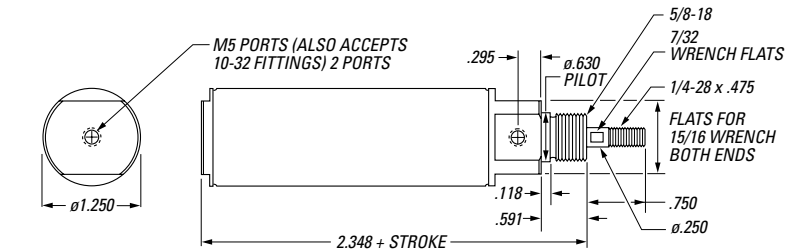

## Part #: E24D...D

Strokes:  
0.5–1.0–1.5–2.0–  
3.0–4.0–5.0–6.0–7.0–  
8.0–9.0–10.0–11.0

Double rod end

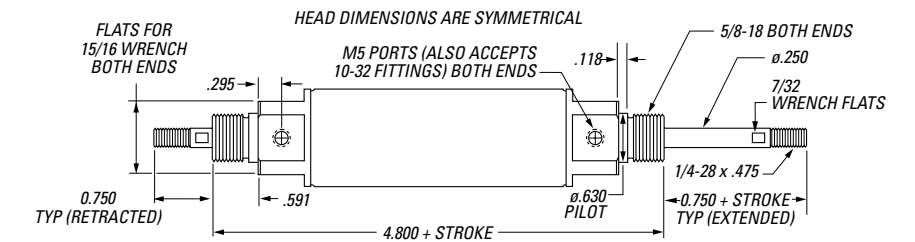

## Part #: E24X...U

Air extend, spring return  
Strokes: 0.5–1.0–1.5–2.0  
Universal mount includes:  
• Rear pivot mount  
• Front, rear stud mount

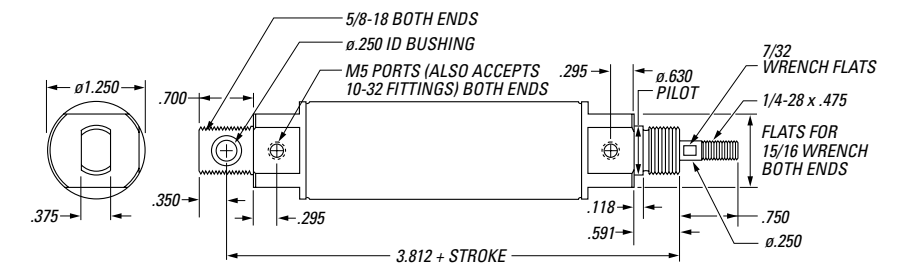

RESET SPRING FORCE FOR SINGLE ACTING UNITS (lbs.)				
Stroke	0.5	1.0	1.5	2.0
Rod Extended	.32	.32	.32	.32
Rod Retracted	.32	.28	.26	.24

## Part #: E24X...N

Air extend, spring return  
Strokes: 0.5–1.0–1.5–2.0  
Front stud mount

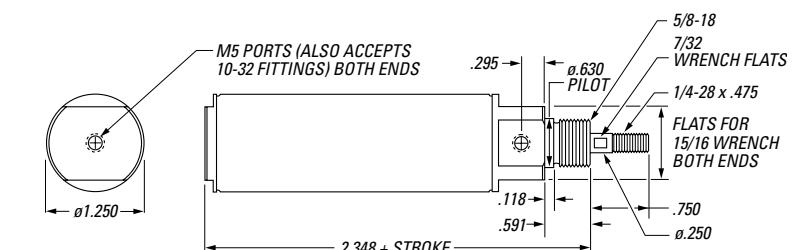

# Model M9

## Bore Size

9.3 mm

## Pressure Range

< 0.0015 to 0.7 MPa

## Force Factors

Factor times pressure (MPa) equals output force (newtons)

- Rear side 67.7
- Rod side 60.0

## Friction Under Pressure

Typically 1%–2% of load in all models

## Temperature Range

-55° Celsius to +150° Celsius  
(-67° F to +302° F)

**Note:** For applications operating below -20° C, it is necessary to add “-ET” to the part number. For example: Model M9D1.0N-ET

## Weight of piston/rod assembly (grams)

Single rod end models  
4.5 + (0.53 x Stroke)

Double rod end models  
8.87 + (0.064 x Stroke)

## Weight (max.) of complete unit (grams)

Single rod end models  
31.7 + (0.375 x Stroke)

Double rod end models  
41.02 + (0.462 x Stroke)

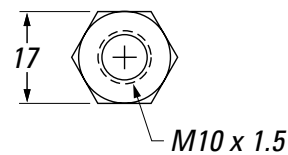

Mounting nut included for all units

DOUBLE ACTING UNITS

SINGLE ACTING UNITS

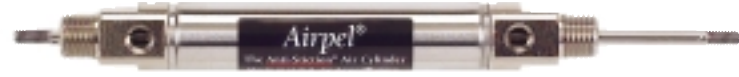

## Part #: M9D<sub>STROKE</sub>U

Strokes:

12.5–25.0–37.5–50.0–75.0–  
100.0–125.0–150.0–175.0–  
200.0–225.0–250.0–275.0–300.0

Universal mount includes:

- Rear pivot mount
- Front, rear stud mount

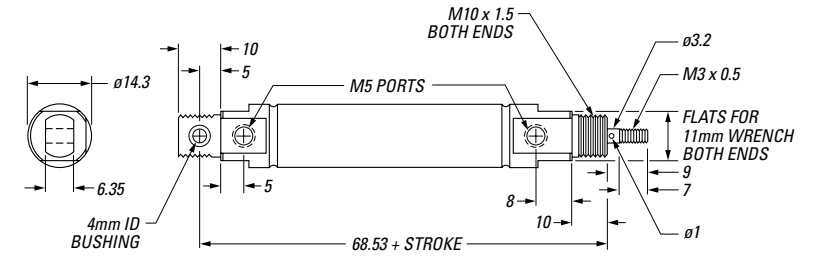

## Part #: M9D<sub>STROKE</sub>N

Strokes:

12.5–25.0–37.5–50.0–75.0–  
100.0–125.0–150.0–175.0–  
200.0–225.0–250.0–275.0–300.0

Front stud mount

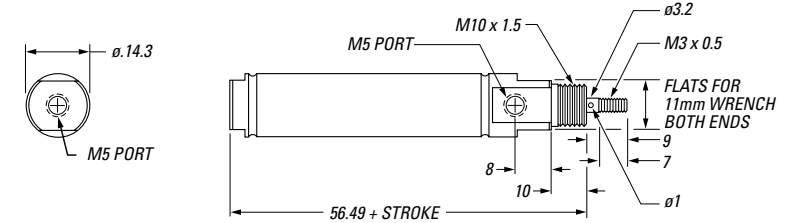

## Part #: M9D<sub>STROKE</sub>S

Strokes:

12.5–25.0–37.5–50.0–75.0–  
100.0–125.0–150.0–175.0–  
200.0–225.0–250.0–275.0–300.0

Front, rear stud mount

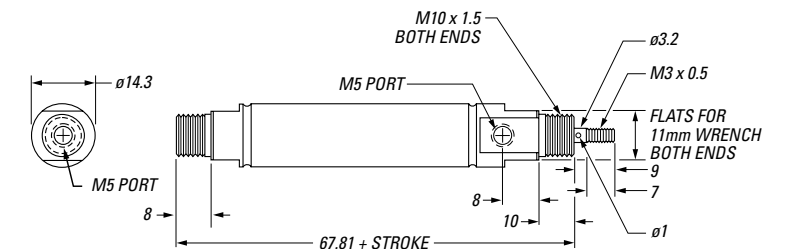

## Part #: M9D<sub>STROKE</sub>D

Strokes:

12.5–25.0–37.5–50.0–75.0–  
100.0–125.0–150.0–175.0–  
200.0–225.0–250.0–275.0–300.0

Double rod end

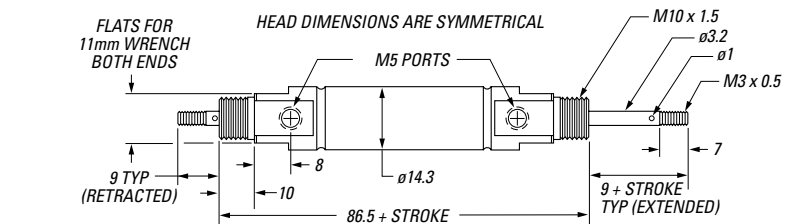

## Part #: M9XD<sub>STROKE</sub>U

Air extend, spring return

Strokes: 12.5–25.0–37.5

Universal mount includes:

- Rear pivot mount
- Front, rear stud mount

RESET SPRING FORCE FOR SINGLE ACTING UNITS (lbs.)			
Stroke	12.5	25.0	37.5
Rod Extended	0.8	0.8	0.8
Rod Retracted	0.5	0.4	0.2

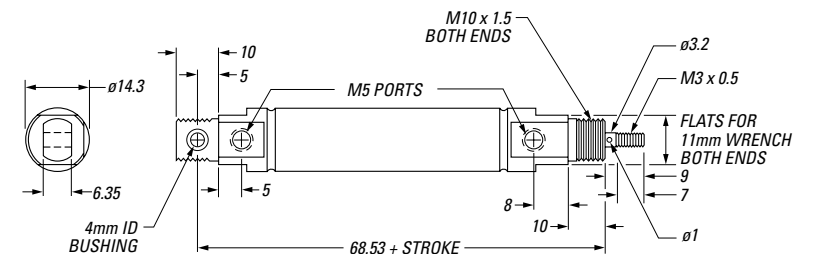

## Part #: M9XD<sub>STROKE</sub>N

Air extend, spring return

Strokes: 12.5–25.0–37.5

Front stud mount

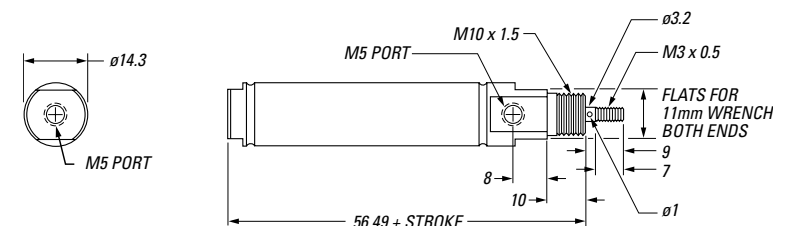



# Model M16

## Bore Size

15.9 mm

## Pressure Range

< 0.0015 to 0.7 MPa

## Force Factors

Factor times pressure (MPa) equals output force (newtons)

- Rear side 198
- Rod side 178

## Friction Under Pressure

Typically 1%–2% of load in all models

## Temperature Range

-55° Celsius to +150° Celsius  
(-67° F to +302° F)

**Note:** For applications operating below -20° C, it is necessary to add “-ET” to the part number. For example: Model M16D1.0N-ET

## Weight of piston/rod assembly (grams)

Single rod end models  
16 + (0.142 x Stroke)

Double rod end models  
28.48 + (0.315 x Stroke)

## Weight (max.) of complete unit (grams)

Single rod end models  
64.6 + (0.622 x Stroke)

Double rod end models  
80.45 + (0.854 x Stroke)

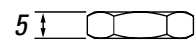
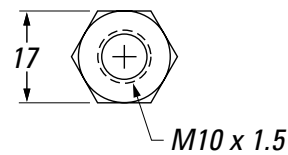

Mounting nut included for all units

DOUBLE ACTING UNITS

SINGLE ACTING UNITS

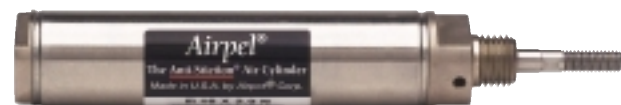
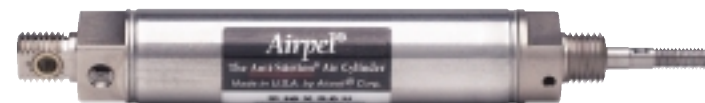
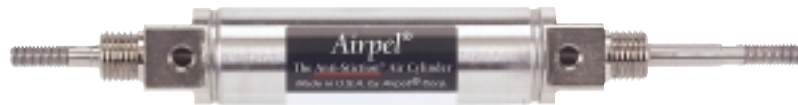
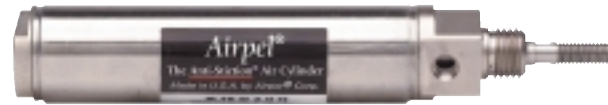

## Part #: M16D...U

Strokes:

12.5–25.0–37.5–50.0–75.0–  
100.0–125.0–150.0–175.0–  
200.0–225.0–250.0–275.0–300.0

Universal mount includes:

- Rear pivot mount
- Front, rear stud mount

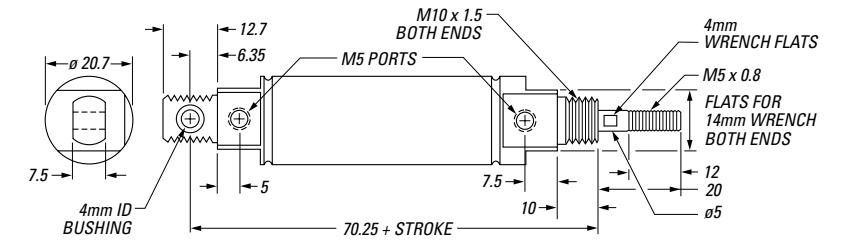

## Part #: M16D...N

Strokes:

12.5–25.0–37.5–50.0–75.0–  
100.0–125.0–150.0–175.0–  
200.0–225.0–250.0–275.0–300.0

Front stud mount

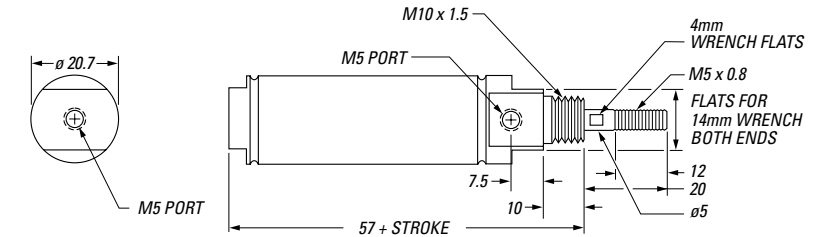

## Part #: M16D...S

Strokes:

12.5–25.0–37.5–50.0–75.0–  
100.0–125.0–150.0–175.0–  
200.0–225.0–250.0–275.0–300.0

Front, rear stud mount

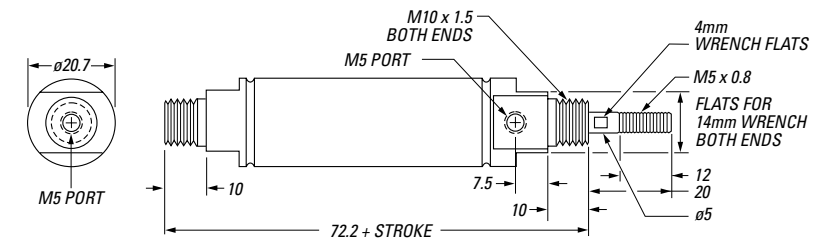

## Part #: M16D...D

Strokes:

12.5–25.0–37.5–50.0–75.0–  
100.0–125.0–150.0–175.0–  
200.0–225.0–250.0–275.0–300.0

Double rod end

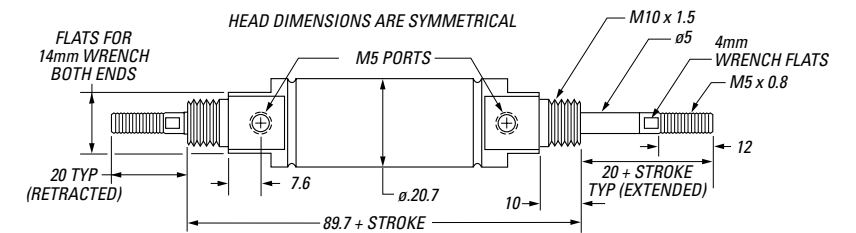

## Part #: M16XD...U

Air extend, spring return

Strokes: 12.5–25.0–37.5–50.0

Universal mount includes:

- Rear pivot mount
- Front, rear stud mount

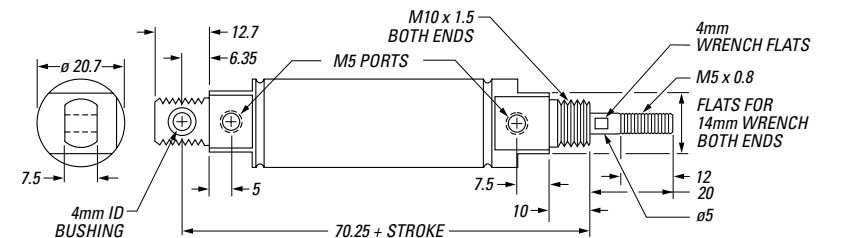

## Part #: M16XD...N

Air extend, spring return

Strokes: 12.5–25.0–37.5–50.0

Front stud mount

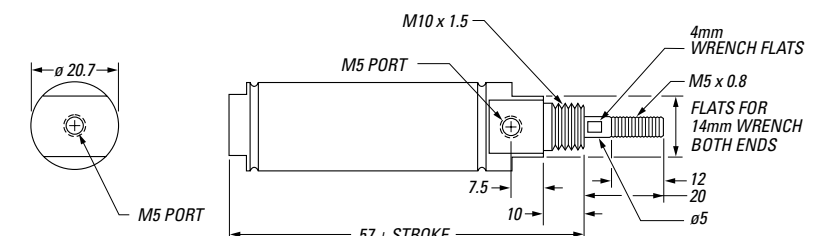

RESET SPRING FORCE FOR SINGLE ACTING UNITS (newtons)				
Stroke	12.5	25.0	37.5	50.0
Rod Extended	1.1	1.1	1.1	1.1
Rod Retracted	1.0	0.9	0.8	0.7



# Model M24

## Bore Size

24.0 mm

## Pressure Range

< 0.0015 to 0.7 MPa

## Force Factors

Factor times pressure (MPa) equals output force (newtons)

- Rear side 452.5
- Rod side 420.8

## Friction Under Pressure

Typically 1%–2% of load in all models

## Temperature Range

-55° Celsius to +150° Celsius  
(-67° F to +302° F)

**Note:** For applications operating below -20° C, it is necessary to add “-ET” to the part number. For example: Model M24D1.0N-ET

## Weight of piston/rod assembly (grams)

Single rod end models  
41.4 + (0.254 x Stroke)

Double rod end models  
74.28 + (0.509 x Stroke)

## Weight (max.) of complete unit (grams)

Single rod end models  
157.18 + (1.225 x Stroke)

Double rod end models  
204.9 + (1.480 x Stroke)

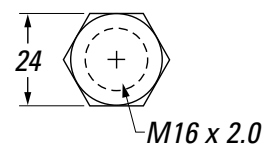

Mounting nut included for all units

DOUBLE ACTING UNITS



## Part #: M24D...U

Strokes:

12.5–25.0–37.5–50.0–75.0–  
100.0–125.0–150.0–175.0–  
200.0–225.0–250.0–275.0–300.0

Universal mount includes:

- Rear pivot mount
- Front, rear stud mount

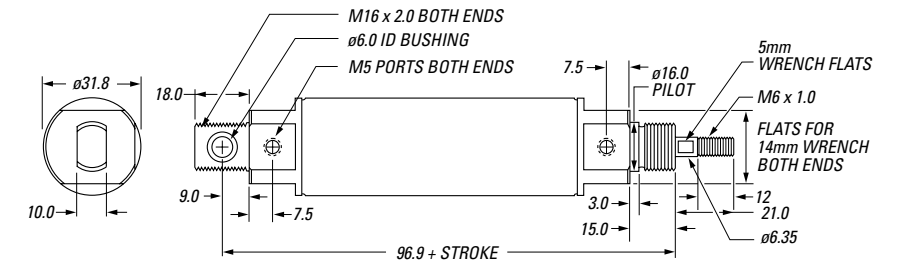

## Part #: M24D...N

Strokes:

12.5–25.0–37.5–50.0–75.0–  
100.0–125.0–150.0–175.0–  
200.0–225.0–250.0–275.0–300.0

Front stud mount

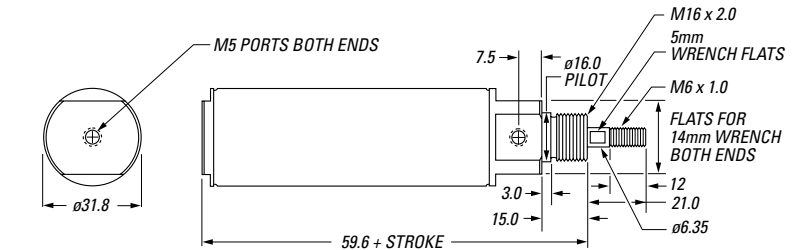

## Part #: M24D...D

Strokes:

12.5–25.0–37.5–50.0–75.0–  
100.0–125.0–150.0–175.0–  
200.0–225.0–250.0–275.0

Double rod end

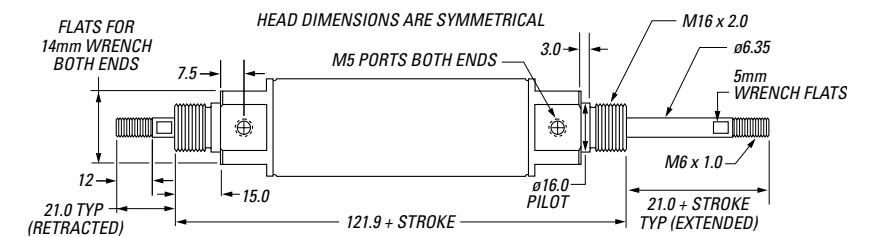

## Part #: M24XD...U

Air extend, spring return

Strokes: 12.5–25.0–37.5–50.0

Universal mount includes:

- Rear pivot mount
- Front, rear stud mount

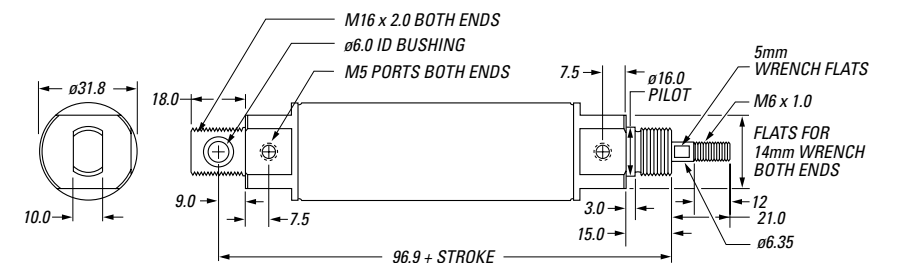

## Part #: M24XD...N

Air extend, spring return

Strokes: 12.5–25.0–37.5–50.0

Front stud mount

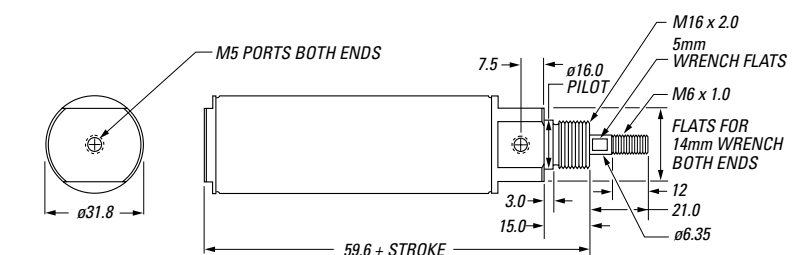

RESET SPRING FORCE FOR SINGLE ACTING UNITS (lbs.)				
Stroke	12.5	25.0	37.5	50.0
Rod Extended	1.44	1.44	1.44	1.44
Rod Retracted	1.34	1.26	1.17	1.09



# Model M32

## Bore Size

32.5 mm

## Pressure Range

< 0.0035 to 0.7 MPa

## Force Factors

Factor times pressure (MPa) equals output force (newtons)

- Rear side 830
- Rod side 751

## Friction Under Pressure

Typically 1%–2% of load in all models

## Temperature Range

-55° Celsius to +150° Celsius  
(-67° F to +302° F)

**Note:** For applications operating below -20° C, it is necessary to add “-ET” to the part number. For example: Model M32D1.0N-ET

## Weight (grams)

Piston/rod assembly only  
82.6 + (0.56 x Stroke)

Complete unit (max.)  
616 + (3.66 x Stroke)

DOUBLE ACTING UNITS

Part #: M32D<sub>STROKE</sub>-U

Strokes:

12.5–25.0–50.0–75.0–100.0

Rear pivot mount

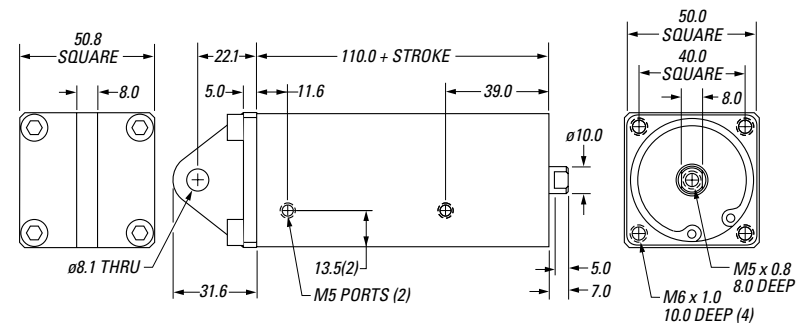

Part #: M32D<sub>STROKE</sub>-N

Strokes:

12.5–25.0–50.0–75.0–100.0

Front/rear mount

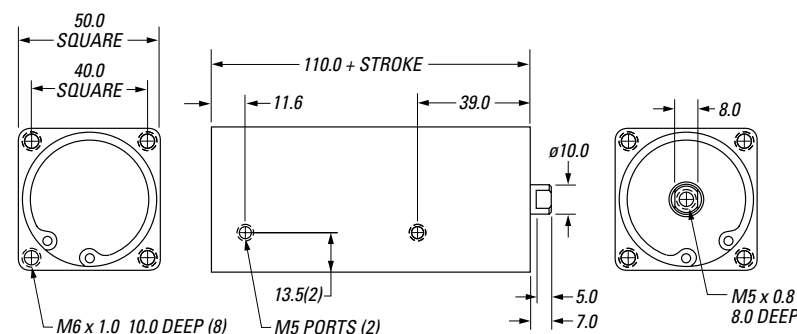

# The company behind Airpel is a company you probably already know.

If you've ever needed an air dashpot or shock absorber, you've probably heard of Airpot Corporation.

For over 35 years, we've been the world's leading manufacturer of precision air-damping dashpots.

Before Airpot® dashpots were considered unpredictable band-aids for the treatment of motion control problems.

Today, just the opposite is true. The precision, reliability and smoothness of Airpot air dashpots and shock absorbers have gained the respect of the world's major producers of semiconductor manufacturing equipment, medical analyzers, and test and measurement equipment.

So it should come as no surprise that Airpot is the company behind Airpel. A company recognized and respected for its technical expertise, its devotion to quality,

and its responsiveness to customers.

But just to give you an extra measure of assurance, we back up our quality and service with a solid warranty.

For two full years following the date of manufacture, we will provide free replacement to the original purchaser of any properly implemented unit which is found to be defective or does not meet published or otherwise agreed-upon specifications.

### The Airpel Warranty

**Airpot will replace or refund your full purchase price, at its option, if there is a defect in materials or workmanship of the Airpel Air Cylinder within two (2) years of purchase, assuming use in accordance with Airpot's specifications. Please refer to your purchase order acknowledgment for the exact terms and limitations of this warranty.**

Would you like to know more about our products? Visit our web site at [www.airpot.com](http://www.airpot.com) for an up-to-the minute catalog and to obtain CAD files; email us at [service@airpot.com](mailto:service@airpot.com); or write Airpel Division, Airpot Corporation, 35 Lois Street, Norwalk, Connecticut 06851. Or feel free to call us at 1-800-848-7681.

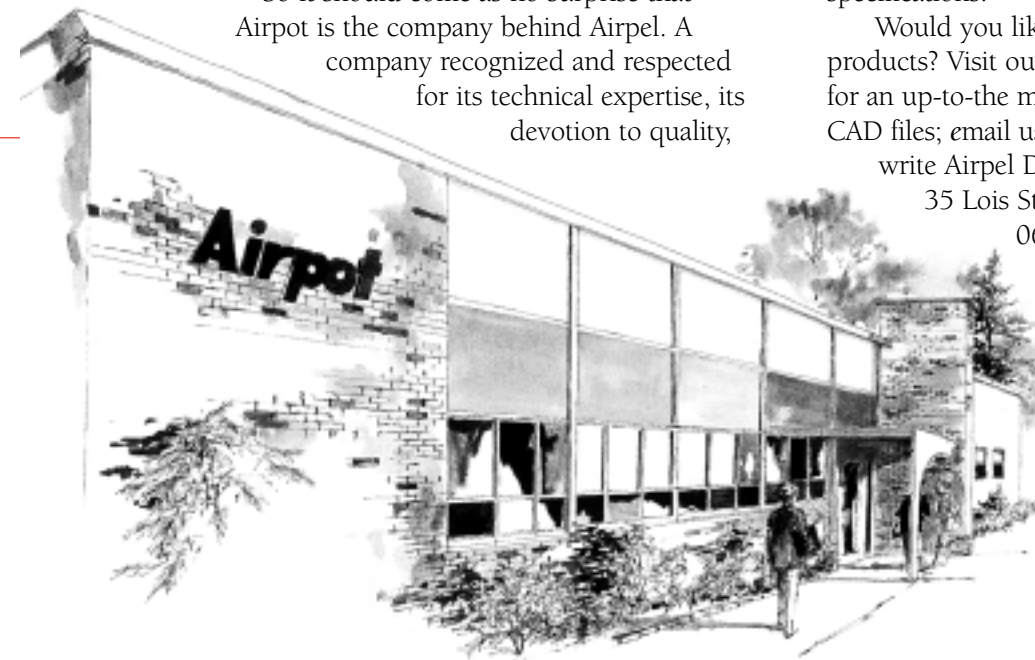

Airpot Corporation, located in Norwalk, Connecticut.



# Here are some of the other precision motion control products we make.

## DASHPOTS

Instrument quality air damping reduces velocity, vibration and oscillation.

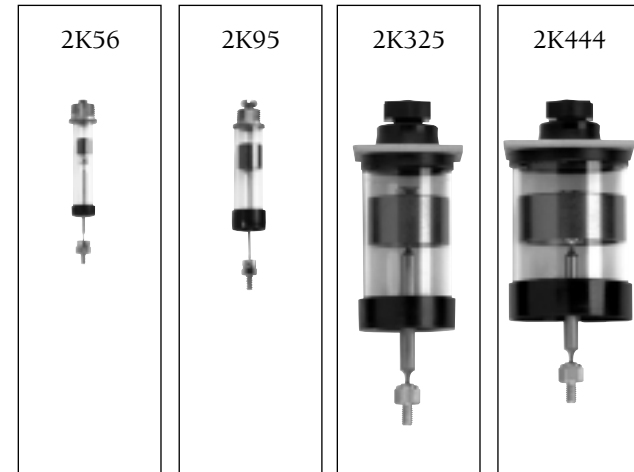

## SNUBBERS

Precise shock absorption for light loads.

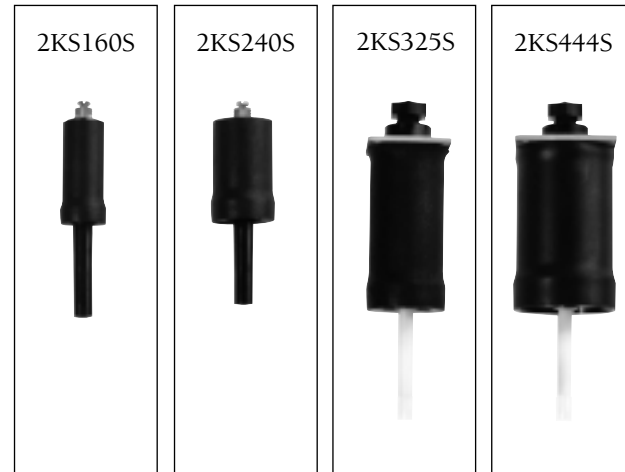

## ACTUATORS

Anti-Stiction and ultra-low friction for sensitive motion.

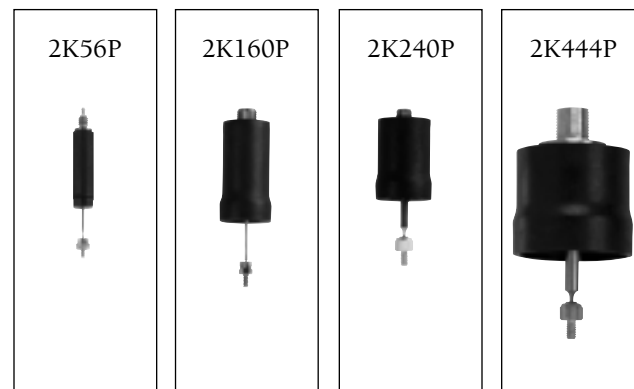

## PISTON-CYLINDER SETS

Ultra-low friction components for your own custom design.



Learn more about our products at [www.airpot.com](http://www.airpot.com)

## Airpot and Airpel USA Sales representatives

### ARIZONA

TECH SALES ASSOCIATES  
P.O. Box 660805  
Arcadia, CA 91066  
(626) 303-1038  
techsls@gte.net

### CALIFORNIA – Northern

LORRING ASSOC.  
7080 Donlon Way, #214  
Dublin, CA 94568  
(925) 803-9565  
Lorring\_assoc@msn.com

### CALIFORNIA – Southern

TECH SALES ASSOC.  
P.O. Box 660805  
Arcadia, CA 91066  
(626) 303-1038  
techsls@gte.net

### CONNECTICUT

ARASON COMPANY  
P.O. Box 1039  
Burlington, MA 01803  
(781) 272-6614  
gureghian@mediaone.net

### DISTRICT OF COLUMBIA

ISOTECH, INC.  
460 Caredean Drive  
Horsham, PA 19044-1325  
(215) 957-5999

### DELAWARE

ISOTECH, INC.  
460 Caredean Drive  
Horsham, PA 19044-1325  
(215) 957-5999

### INDIANA

APPLIED MOTION PRODUCTS  
8039, 24th Avenue South  
Bloomington, MN 55425-1244  
(612) 854-1410  
sales@appliedmotion.com  
www.appliedmotion.com

### MAINE

ARASON COMPANY  
P.O. Box 1039  
Burlington, MA 01803  
(781) 272-6614  
gureghian@mediaone.net

### MARYLAND

ISOTECH, INC.  
460 Caredean Drive  
Horsham, PA 19044-1325  
(215) 957-5999

### MASSACHUSETTS

ARASON COMPANY  
P.O. Box 1039  
Burlington, MA 01803  
(781) 272-6614  
gureghian@mediaone.net

### MINNESOTA

APPLIED MOTION PRODUCTS  
8039, 24th Avenue South  
Bloomington, MN 55425-1244  
(612) 854-1410  
sales@appliedmotion.com  
www.appliedmotion.com

### NEVADA

LORRING ASSOC.  
7080 Donlon Way, #214  
Dublin, CA 94568  
(925) 803-9565  
Lorring\_assoc@msn.com

### NEW HAMPSHIRE

ARASON COMPANY  
P.O. Box 1039  
Burlington, MA 01803  
(781) 272-6614  
gureghian@mediaone.net

### NEW JERSEY

ISOTECH, INC.  
460 Caredean Drive  
Horsham, PA 19044-1325  
(215) 957-5999

### NEW YORK – Upstate

SCHUMACHER SALES  
25 Great Oak Lane  
Pittsford, N.Y. 14534  
(716) 987-9398  
pschuma@rochester.rr.com

### NORTH CAROLINA

HUBERT JENKS  
2513 McGowen Court  
Wake Forest, N.C. 27587  
(919) 554-4001

### NORTH DAKOTA

APPLIED MOTION PRODUCTS  
8039, 24th Avenue South  
Bloomington, MN 55425-1244  
(612) 854-1410  
sales@appliedmotion.com  
www.appliedmotion.com

**PENNSYLVANIA – Eastern**

ISOTECH, INC.  
460 Caredean Drive  
Horsham, PA 19044-1325  
(215) 957-5999

**PENNSYLVANIA – Western**

PRECISION RESOURCES  
9 Greenbrier Lane  
Willow Street, PA 17584  
(717) 464-1299  
mcubbison@aol.com

*and*

ENGLE ASSOCIATES  
107 First Avenue  
P.O. Box 604  
Langeloth, PA 15054-0604  
(412) 947-4950

**SOUTH DAKOTA**

APPLIED MOTION PRODUCTS  
8039, 24th Avenue South  
Bloomington, MN 55425-1244  
(612) 854-1410  
sales@appliedmotion.com  
www.appliedmotion.com

**VERMONT**

ARASON COMPANY  
P.O. Box 1039  
Burlington, MA 01803  
(781) 272-6614  
gureghian@mediaone.net

**WISCONSIN – Western**

APPLIED MOTION PRODUCTS  
8039, 24th Avenue South  
Bloomington, MN 55425-1244  
(612) 854-1410  
sales@appliedmotion.com  
www.appliedmotion.com

**ARIZONA**

TECH SALES ASSOCIATES  
P.O. Box 660805  
Arcadia, CA 91066  
(626) 303-1038  
techsls@gte.net

**CALIFORNIA-NORTHERN**

NORCAL CONTROLS, INC.  
1400 Coleman Ave., Suite H-12  
Santa Clara, CA 95050  
(408) 727-5756  
ncc4air@pacbell.net  
www.norcal4air.com

**CALIFORNIA-SOUTHERN**

TECH SALES ASSOCIATES  
P.O. Box 660805  
Arcadia, CA 91066  
(626) 303-1038  
techsls@gte.net

**COLORADO**

ADVANCED AIR PRODUCTS CO.  
1163 S. Cherokee  
Denver, CO 80223  
(303) 778-0800

*and*

2950 South 125th West  
Salt Lake City, UT 84115  
(801) 466-1111  
Charlie\_smith@uswest.net  
www.advancedairproducts.com

**CONNECTICUT**

OHLHEISER CORP.  
P.O. Box 330249  
W. Hartford, CT 06133-0249  
(860) 953-7632  
info@ohlheiser.com  
www.ohlheiser.com

**CONNECTICUT**

OHLHEISER CORP.  
P.O. Box 330249  
W. Hartford, CT 06133-0249  
(860) 953-7632  
info@ohlheiser.com  
www.ohlheiser.com

**CONNECTICUT**

OHLHEISER CORP.  
P.O. Box 330249  
W. Hartford, CT 06133-0249  
(860) 953-7632  
info@ohlheiser.com  
www.ohlheiser.com

**CONNECTICUT**

OHLHEISER CORP.  
P.O. Box 330249  
W. Hartford, CT 06133-0249  
(860) 953-7632  
info@ohlheiser.com  
www.ohlheiser.com

**ILLINOIS**

AC SUPPLY, INC.  
8220 W. Sleske Court  
Milwaukee, WI 53223-0600  
(414) 357-7350  
dianem@acsupplyinc.com

**INDIANA**

APPLIED MOTION PRODUCTS  
8039, 24th Avenue South  
Bloomington, MN 55425-1244  
(612) 854-1410  
sales@appliedmotion.com  
www.appliedmotion.com

**FLORIDA**

KERSHAW AUTOMATION  
P.O. Box 1068  
Oldsmar, FL 34677  
(813) 855-4425  
www.kershawautomation.com

**GEORGIA**

CAROLINA FLUID COMPONENTS  
9309 Stockport  
Charlotte, NC 28273  
(704) 588-6101

**MASSACHUSETTS**

OHLHEISER CORP.  
P.O. Box 330249  
W. Hartford, CT 06133-0249  
(860) 953-7632  
info@ohlheiser.com  
www.ohlheiser.com

**MICHIGAN**

SUNSOURCE  
1500 E. Avis Drive  
Madison Heights, MI 48071  
(248) 585-5252  
ckrawer.sunsorce.com  
www.sun-source.com

**MINNESOTA**

APPLIED MOTION PRODUCTS  
8039, 24th Avenue South  
Bloomington, MN 55425-1244  
(612) 854-1410  
sales@appliedmotion.com  
www.appliedmotion.com

**NEVADA**

NORCAL CONTROLS, INC.  
1400 Coleman Ave., Suite H-12  
Santa Clara, CA 95050  
(408) 727-5756  
ncc4air@pacbell.net  
www.norcal4air.com

**NEW HAMPSHIRE**

OHLHEISER CORP.  
P.O. Box 330249  
W. Hartford, CT 06133-0249  
(860) 953-7632  
info@ohlheiser.com  
www.ohlheiser.com

**NEW MEXICO**

ADVANCED AIR PRODUCTS CO  
2950 South 125th West  
Salt Lake City, UT 84115  
(801) 466-1111  
Charlie\_smith@uswest.net  
www.advancedairproducts.com

**NEW YORK – Upstate**

COMPONENT SUPPLY  
6714 Lakeside Road  
Ontario, NY 14519-9325  
(315) 524-2291  
compsupply@frontier.net  
www.componentsupply.com



**NORTH DAKOTA**

APPLIED MOTION PRODUCTS  
8039, 24th Avenue South  
Bloomington, MN 55425-1244  
(612) 854-1410  
sales@appliedmotion.com  
www.appliedmotion.com

**OREGON**

NORTHWEST PNEUMATICS, INC.  
7190 S.W. Sandburg, Suite 20  
Portland, OR 97223-8037  
(503) 620-5670  
sales@nwpneu.com

**RHODE ISLAND**

OHLHEISER CORP.  
P.O. Box 330249  
W. Hartford, CT 06133-0249  
(860) 953-7632  
info@ohlheiser.com  
www.ohlheiser.com

**SOUTH DAKOTA**

APPLIED MOTION PRODUCTS  
8039, 24th Avenue South  
Bloomington, MN 55425-1244  
(612) 854-1410  
sales@appliedmotion.com  
www.appliedmotion.com

**UTAH**

ADVANCED AIR PRODUCTS CO  
2950 South 125th West  
Salt Lake City, UT 84115  
(801) 466-1111  
Charlie\_smith@uswest.net  
www.advancedairproducts.com

**VERMONT**

OHLHEISER CORP  
P.O. Box 330249  
W. Hartford, CT 06133-0249  
(860) 953-7632  
info@ohlheiser.com  
www.ohlheiser.com

**WASHINGTON – Southwest**

NORTHWEST PNEUMATICS, INC.  
7190 S.W. Sandburg, Suite 20  
Portland, OR 97223-8037  
(503) 620-5670  
sales@nwpneu.com

**WISCONSIN – Eastern**

AC SUPPLY, INC.  
8220 W. Sleske Court  
Milwaukee, WI 53223-0600  
(414) 357-7350  
dianem@acsupplyinc.com

**WISCONSIN – Western**

APPLIED MOTION PRODUCTS  
8039, 24th Avenue South  
Bloomington, MN 55425-1244  
(612) 854-1410  
sales@appliedmotion.com  
www.appliedmotion.com

**WYOMING**

ADVANCED AIR PRODUCTS CO.  
1163 S. Cherokee  
Denver, CO 80223  
(303) 778-0800

**and**

2950 South 125th West  
Salt Lake City, UT 84115  
(801) 466-1111  
Charlie\_smith@uswest.net  
www.advancedairproducts.com

**CANADA**

ROBERT CROTHERS ASSOC.  
4500 Sheppard Ave. E, Unit 31  
Scarborough, Ontario  
M1S 3R6 CANADA  
416-292-7901  
info@robertcrothers.co  
www.robertcrothers.com



Airpel Division ■ Airpot Corporation ■ 35 Lois Street  
Norwalk, CT 06851 ■ 1-800-848-7681 ■ Fax: 203-849-0539  
Email: [service@airpot.com](mailto:service@airpot.com) ■ [www.airpot.com](http://www.airpot.com)

***Airpel***<sup>®</sup>  
The Anti-Stiction<sup>®</sup> Air Cylinder.